

SIMATIC NET

## **GPRS/GSM-Modem SINAUT MD720-3**

System manual

Preface, Contents

---

**Introduction 1**

---

**Inserting the SIM card 2**

---

**Connecting the device and  
switching on the device 3**

---

**SINAUT MD720-3 in Terminal  
Mode 4**

---

**SINAUT MD720-3 in OPC Mode 5**

---

**Service function 6**

---

**Technical Data 7**

---

Glossary

---

**C79000-G8976-C211**

**Release 02/2006**

## Safety Guidelines

This manual contains notices you have to observe in order to ensure your personal safety, as well as to prevent damage to property. The notices referring to your personal safety are highlighted in the manual by a safety alert symbol, notices referring only to property damage have no safety alert symbol. These notices shown below are graded according to the degree of danger.



---

### Danger

indicates that death or severe personal injury **will** result if proper precautions are not taken.

---



---

### Warning

indicates that death or severe personal injury **may** result if proper precautions are not taken.

---



---

### Caution

with a safety alert symbol, indicates that minor personal injury can result if proper precautions are not taken.

---

---

### Caution

without a safety alert symbol, indicates that property damage can result if proper precautions are not taken.

---

---

### Notice

indicates that an unintended result or situation can occur if the corresponding information is not taken into account.

---

If more than one degree of danger is present, the warning notice representing the highest degree of danger will be used. A notice warning of injury to persons with a safety alert symbol may also include a warning relating to property damage.

## Qualified Personnel

The device/system may only be set up and used in conjunction with this documentation. Commissioning and operation of a device/system may only be performed by **qualified personnel**. Within the context of the safety notes in this documentation qualified persons are defined as persons who are authorized to commission, ground and label devices, systems and circuits in accordance with established safety practices and standards.

## Prescribed Usage

Note the following:



---

### Warning

This device may only be used for the applications described in the catalog or the technical description and only in connection with devices or components from other manufacturers which have been approved or recommended by Siemens. Correct, reliable operation of the product requires proper transport, storage, positioning and assembly as well as careful operation and maintenance.

---

## Trademarks

All names identified by ® are registered trademarks of the Siemens AG. The remaining trademarks in this publication may be trademarks whose use by third parties for their own purposes could violate the rights of the owner.

## Disclaimer of Liability

We have reviewed the contents of this publication to ensure consistency with the hardware and software described. Since variance cannot be precluded entirely, we cannot guarantee full consistency. However, the information in this publication is reviewed regularly and any necessary corrections are included in subsequent editions.

## General

The product SINAUT MD720-3 complies with European standard EN60950, 05.2003, Safety of Information Technology Equipment.

Read the installation instructions carefully before using the device.

Keep the device away from children, especially small children.

The device must not be installed or operated outdoors or at damp locations.

Do not operate the device if the connecting leads or the device itself are damaged.

## External power supply

Use only an external power supply which also complies with EN60950. The output voltage of the external power supply must not exceed 30VDC. The output of the external power supply must be short-circuit proof.



---

### Warning

The power supply unit to supply the SINAUT MD720-3 must comply with NEC Class 2 circuits as outlined in the National Electrical Code (ANSI/NFPA 70) only.

---

When connecting to a battery or accumulator, make sure that an all-pole circuit-breaker (main battery switch) with sufficient selectivity and a fuse with sufficient selectivity are provided between the device and the battery or accumulator.

Please pay regard to section 7 *Technical Data* of the system manual, as well as the installation and utilisation regulations of the respective manufacturers of the power supply, the battery or the accumulator.

## SIM card

To install the SIM card the device must be opened. Before opening the device, disconnect it from the supply voltage. Static charges can damage the device when it is open. Discharge the electric static of your body before opening the device. To do so, touch an earthed surface, e.g. the metal casing of the switch cabinet. Please pay regard to section 2 *Inserting the SIM card* of this system manual.

## Handling cables

Never pull a cable connector out of a socket by its cable, but pull on the connector itself. Cable connectors with screw fasteners (D-Sub) must always be screwed on tightly. Do not lay the cable over sharp corners and edges without edge protection. If necessary, provide sufficient strain relief for the cables.

For safety reasons, make sure that the bending radius of the cables is observed.

Failure to observe the bending radius of the antenna cable results in the deterioration of the system's transmission and reception properties. The minimum bending radius static must not fall below 5 times the cable diameter and dynamic below 15 times the cable diameter.

## Radio device

---



### Warning

Never use the device in places where the operation of radio devices is prohibited. The device contains a radio transmitter which could in certain circumstances impair the functionality of electronic medical devices such as hearing aids or pacemakers. You can obtain advice from your physician or the manufacturer of such devices. To prevent data carriers from being demagnetised, do not keep disks, credit cards or other magnetic data carriers near the device.

---

## Installing antennas

---



### Warning

The emission limits as recommended by the Commission on Radiological Protection (13/14 September 2001) must be observed.

---

## Installing an external antenna

---

### Caution

When installing an antenna outdoors it is essential that the antenna is fitted correctly by a qualified person. Lightning Protection Standard VDE V 0185 Sections 1 to 4, in its current version, and further standards must be observed.

---

## Lightning protection category for buildings

---

### Caution

For outdoor installation, the antenna may be fitted only within the lightning protection zones O/E or 1. These lightning protection zones are prescribed by the lightning protection spherical radius.

---

## The EMV lightning protection zone concept

---

### Caution

The EMV lightning protection zone concept is to be observed. To avoid large induction loops a lightning protection equipotential bonding is to be used. If the antenna or antenna cable is installed near to the lightning protection system, the minimum distances to the lightning protection system must be observed. If this is not possible, insulated installation as described in VDE V 0185 Sections 1 to 4, in its current version, is essential.

---

### FCC Part 15

This equipment has been tested and found to comply with the limits for a Class A digital device, pursuant to Part 15 of the FCC Rules. These limits are designed to provide reasonable protection against harmful interference in a residential installation. This equipment generates, uses and can radiate radio frequency energy and, if not installed and used in accordance with the instructions, may cause harmful interference to radio communications. However, there is no guarantee that interference will not occur in a particular installation. If this equipment does cause harmful interference to radio or television reception, which can be determined by turning the equipment off and on, the user is encouraged to try to correct the interference by one or more of the following measures:

- Reorient or relocate the receiving antenna.
- Increase the separation between the equipment and receiver.
- Connect the equipment into an outlet on a circuit different from that to which the receiver is connected.
- Consult the dealer / installer or an experienced radio/TV technician for help.

### FCC Part 15.19

This device complies with Part 15 of the FCC Rules. Operation is subject to the following two conditions:

1. this device may not cause harmful interference, and
2. this device must accept any interference received, including interference that may cause undesired operation.

## FCC Part 15.21

Modifications not expressly approved by this company could void the user's authority to operate the equipment.

### Installation by qualified personnel only

You may only use the SINAUT MD720-3 with an antenna of the SINAUT MD720-3 accessory program.

The installation of the SINAUT MD720-3 and the antenna as well as servicing is to be performed by qualified technical personnel only. When servicing the antenna, or working at distances closer than those listed below, ensure the transmitter has been disabled.

### RF Exposure mobile

---

#### Caution

Typically, the antenna connected to the transmitter is an omni-directional antenna with 0dB gain. Using this antenna the total composite power in PCS mode is smaller than 1 watt ERP.

The internal / external antennas used for this mobile transmitter must provide a separation **distance of at least 20 cm from all persons** and must not be co-located or operating in conjunction with any other antenna or transmitter."

---

---

#### Caution

This is a class A equipment. This equipment can disturb other electric equipment in living areas; in this case the operator can be demanded to carry out appropriate measures.

---

---

#### Caution

Please note that data packets exchanged for setting up connections, reconnecting, connect attempts (e.g. Server switched off, wrong destination address, etc.) as well as keeping the connection alive are also subject to charge.

---

# Preface

## Purpose of this documentation

This documentation will support you on your way to successful application of SINAUT MD720-3. It will introduce you to the topic in clear and straightforward steps and provide you with an overview of the hardware of the SINAUT MD720-3 GSM/GPRS modem. This documentation will help you during installation and commissioning of SINAUT GSM/GPRS modem and explains the diagnostics and service options available.

## Validity of the documentation

This manual relates to the following product versions

- GPRS/GSM modem MD720-3 hardware release 3.x

## SIMATIC Technical Support

You can contact Technical Support for all A&D products

- Phone: +49 (0) 180 5050 222
- Fax: +49 (0) 180 5050 223

You will find further information on our Technical Support on the Web at <http://www.siemens.com/automation/service>

## Service & Support on the Internet

In addition to our documentation services, you can also make use of all our knowledge on the Internet:

<http://www.siemens.com/automation/service&support>

Here, you will find:

- Up-to-date product information (Updates), FAQs (Frequently Asked Questions), Downloads, Tips and Tricks.
- The Newsletter keeps you constantly up to date with the latest information on the products you use.
- The Knowledge Manager will find the documents you need.
- In the Forum, users and specialists exchange information and experience.
- You can find your local contact for Automation & Drives in our contacts database.
- You will find information on local service, repairs, spares and much more under the rubric "Service".

You will find the latest version of this documentation under the entry ID 22549543.

Do you still have questions relating to the use of the products described in the manual? If so, then please talk to your local Siemens contact.

You will find the addresses in the following sources:

- On the Internet at: <http://www.siemens.com/automation/partner>
- On the Internet at <http://www.siemens.com/simatic-net> specifically for SIMATIC NET products
- In the catalog CA 01
- In the catalog IK PI specifically for SIMATIC NET products

### **SIMATIC training center**

To familiarize you with the systems and products, we offer a range of courses. Please contact your regional training center or the central training center in

D-90327 Nuernberg.

Phone: +49 (911) 895-3200

<http://www.sitrain.com>

### **SIMATIC NET training center**

For courses specifically on products from SIMATIC NET, please contact:

SIEMENS AG

Siemens AG, A&D Informations- und Trainings-Center

Dynamostr. 4

D-68165 Mannheim

Phone: +49 (621) 4 56-23 77

Fax: +49 (621) 4 56-32 68



# Contents

<b>Preface</b> .....	<b>7</b>
<b>1 Introduction</b> .....	<b>11</b>
<b>2 Inserting the SIM card</b> .....	<b>13</b>
<b>3 Connecting the device and switching on the device</b> .....	<b>19</b>
<b>4 SINAUT MD720-3 in Terminal Mode</b> .....	<b>23</b>
4.1 Terminal mode activation.....	23
4.2 Operating requirements: GPRS subscriber contract.....	24
4.3 Functions of the LEDs in Terminal Mode.....	24
4.4 Terminal mode operation.....	25
4.5 Entering AT commands.....	26
4.6 Use AT commands.....	28
4.7 Supported AT commands in Terminal Mode.....	30
<b>5 SINAUT MD720-3 in OPC Mode</b> .....	<b>51</b>
5.1 OPC Mode activation.....	52
5.2 Functions of the LEDs in OPC Mode.....	53
5.3 PIN in OPC-Mode.....	54
5.4 Log in to SINAUT MICRO SC.....	56
<b>6 Service functions</b> .....	<b>57</b>
6.1 Switching between Terminal mode and OPC Mode.....	57
6.2 Getting the current settings and values.....	59
6.3 Service mode to download a new firmware.....	60
6.4 Load factory defaults.....	64
<b>7 Technical Data</b> .....	<b>65</b>
<b>Glossary</b> .....	<b>69</b>



# Introduction

# 1

The SINAUT MD720-3 has two different operation modes:

- Terminal Mode
- OPC Mode

The functional range and the functionality of the device are different in both modes. The change between OPC Mode and Terminal Mode (refer to page 23 or page 52) forces a restart of the device.

## Terminal mode

The SINAUT MD720-3 establishes radio data connections via a GSM network (Global System for Mobile Communication).

- using modem connections via CSD (**C**ircuit **S**witched **D**ata),
- by sending SMS (**S**hort **M**essage **S**ervice).

---

### Notice

You will find further information about the Terminal Mode and its use in combination with TIM devices of the SINAUT ST7 system in the system manual of the SINAUT ST7.

---

## OPC-Modus

The SINAUT MD720-3 transmits data over via a GSM radio network (Global System for Mobile Communication).

- using GPRS (**G**eneral **P**acket **R**adio **S**ervice) between S7-200 devices and an OPC server SINAUT MICRO SC,
- using SMS from a S7-200-device to any remote station, which can receive SMS.

Therefore the SINAUT MD720-3 will be configured by program building blocks of the connected PLC. The SINAUT MD720-3 establishes autonomous the radio data connection via GPRS between a S7-200 device and the OPC server SINAUT MICRO SC.

---

### Notice

You will find information about the OPC Mode in the system manual of the SINAUT MICRO SC.

---

# Inserting the SIM card

# 2

---

**Notice**

- The device must be switched off when you insert or change the SIM card.
  - A plug-in SIM card (3 V) is used.
- 

**Changing the SIM card**

If you change the SIM card, please do not forget to update also the PIN number in your application.

If you use a lot of SIM cards it can be helpful to set all PINs to the same PIN number. You can do this i.e. by using a mobile phone. Please observe the security requirements of your organization.

To insert the SIM card proceed as follows:

1. Make sure that the device is disconnected from the supply voltage.
2. The SINAUT MD720-3 must be opened to insert the SIM card.

The housing is fastened by two clamps, one on top of the housing and one on the bottom side (see figure 2-1).



figure 2-1

3. With a suitable object press one of the clamps cautiously (see figure 2-2) so that the catch opens.

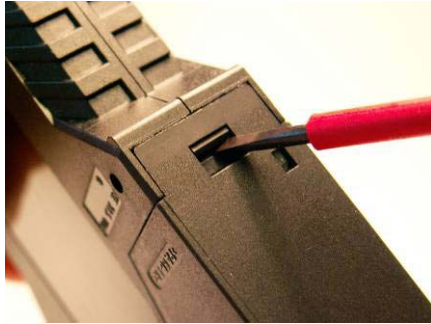

figure 2-2

4. Remove the rear section of the housing (see figure 2-3).



figure 2-3

5. The SIM card holder is visible on the motherboard. (see figure 2-4).

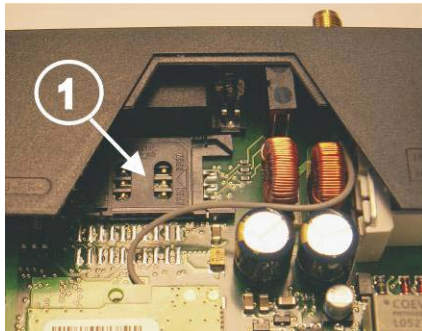

1 - SIM card holder

figure 2-4

6. With a suitable object open the flap of the SIM card holder by moving it cautiously about 2 mm to the left - in the direction of the arrow (see red arrow in figure 2-5) so that it can be raised.

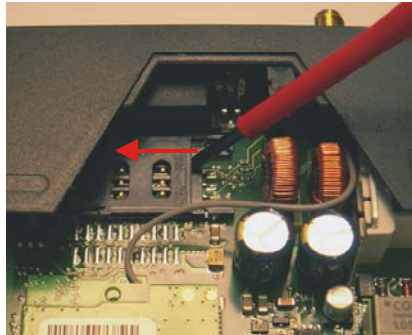

figure 2-5

7. Raise the flap of the SIM card holder so that you can insert the SIM card. (see figure 2-6).

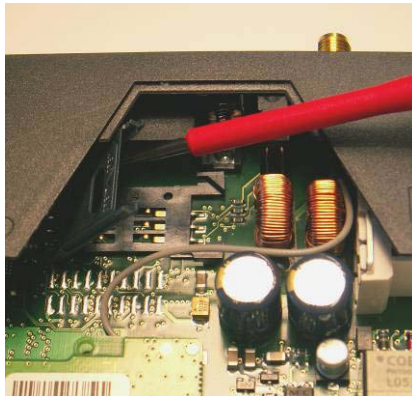

figure 2-6

8. In figure 2-7, the compartment into which you can insert the SIM card is emphasized in white.

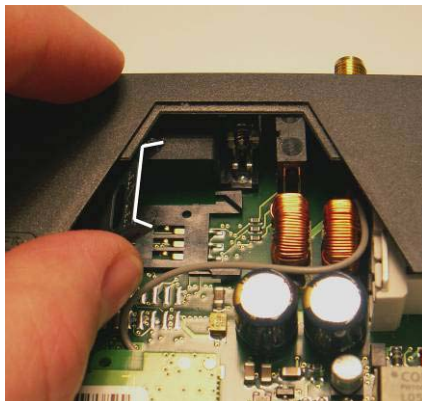

figure 2-7

- Slide the SIM card into the flap of the SIM card holder, with the gold-coloured microchip pointing down. The flap has a groove for this purpose. The notched corner of the SIM card has to point towards the front of the device (see figure 2-8).



figure 2-8

- Slide the SIM card down into the flap as far as possible (see figure 2-9).



figure 2-9

- Lower the flap paying attention to the notched corner of the SIM card (see figure 2-10).

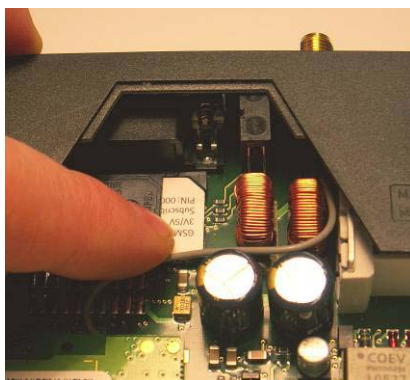

figure 2-10



12. With your fingernail or a suitable object move the flap about 2 mm to the right (in the direction of the arrow, see figure 2-11) until you can feel it click into place.

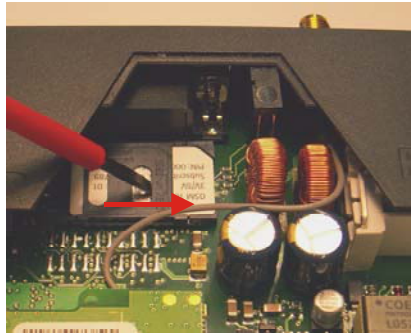

figure 2-11

13. Now the SIM card holder is locked into position (see figure 2-12).



figure 2-12

14. Finally re-attach both housing parts:

Slide the motherboard into the rails on top and bottom inside the rear section of the housing. Close the housing by slightly pressing both housing parts together so that the clamps on the upper and lower part of the housing engage (see figure 2-13).

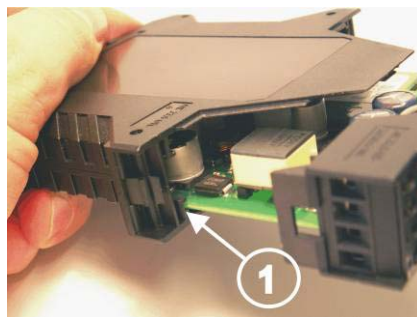

figure 2-13

1 - SIM card holder

15. The housing is locked when both clamps have clicked shut (see figure 2-14).

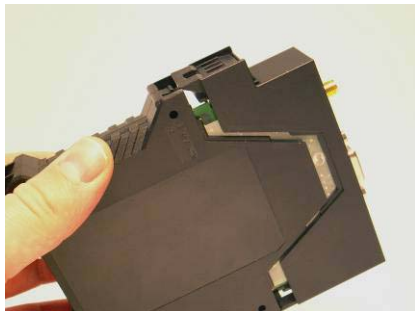
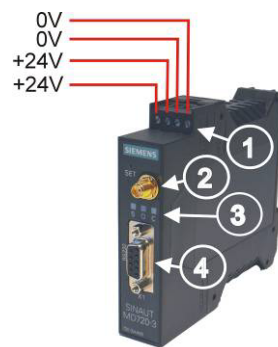

figure 2-14

# Connecting the device and switching on the device

# 3

## Connectors and LEDs



- 1 - Connectors for supply voltage  
24 V DC voltage (nominal)
- 2 - Antenna
- 3 - LEDs: S (Status)  
Q (Quality)  
C (Connect)
- 4 - X1 (RS232)  
For connection of the application  
OR  
or the service PC

figure 3-1

## Antenna

The antenna connector – SMA socket - is situated on the upper part of the front.

Impedance: approx. 50 Ohm

---

### Caution

Please use only antennas of the SINAUT MD720-3 accessory program. Other antennas may disturb the product characteristics and may even cause defects.

---

## Connectors for current supply

The screw terminals on the top of the device are for connecting the current supply: 24 V DC voltage (nominal),  $I_{typ.} 260mA@24V$ . (Please also refer to chapter 7 *Technical Data*.) Both screw terminals on the left (24V) are internally connected, see figure 3-1. Both screw terminals on the right (0V) are internally connected.

## Switching on

The device switches on as soon as the operating voltage is supplied.

## Functions of the LEDs

The SINAUT MD720-3 has three LEDs, which are used to indicate the device status. The function of the LEDs is different in terminal and OPC Mode. You will find the explanation of the function

- in Terminal Mode in chapter 4.3 *Functions of the LEDs in Terminal Mode* and
- in OPC Mode in chapter 5.2 *Functions of the LEDs in OPC Mode*.

## Serial interface X1

### For data transmission:

Connect the application (e.g. machine, vending machine, sensor, computer) with the interface **X1** of the SINAUT MD720-3. To connect, use a RS-232 cable.

If the application has a different interface, e.g. CAN, PPI cable or a different industry bus, a commercially available interface converter can be connected between it and the SINAUT MD720-3.

OR

### For configuration and service:

Connect the service PC via its serial interface (COM port). To connect, use a RS-232 cable.

## The SET button

By pushing the SET button for a certain period of time, you can configure the device or activate different service modes.

Pushing the SET button		LED Status	Function
while connecting the supply voltage	→	The LEDs start to light up in sequence signalling the boot sequence	Switch between the operating modes Terminal Mode ↔ OPC Mode
during operation for less than 2 seconds	→	The LED „S“ (Status) begins to light	Dump of current settings and values issued via the RS232 interface
during operation for 2-4 seconds	→	The LED „Q“ (Quality) begins to light	Service mode to download a new firmware
during operation for more than 4 seconds	→	Die LED „C“ (Connect) begins to light	Load factory settings

## Top-hat rail mounting

The SINAUT MD720-3 is suitable for top-hat rail mounting on DIN EN 50022 rails. A corresponding bracket can be found at the rear of the device.



# SINAUT MD720-3 in Terminal Mode

# 4

In the Terminal Mode the SINAUT MD720-3 operates like a GSM modem, which is controlled by AT commands.

Supported are

- incoming and outgoing GSM data connections with 9600 bps with modems being connected to the GSM network, the ISDN or the analogue telephone network,
- sending of SMS (**S**hort **M**essage **S**ervice).

## 4.1 Terminal mode activation

### Terminal mode is the factory default setting

The SINAUT MD720-3 supports two fundamental operation modes:

- Terminal Mode,
- OPC Mode.

The SINAUT MD720-3 is delivered by the factory with activated Terminal Mode.

### Switching from OPC Mode into the Terminal Mode

If it is necessary to switch manually the SINAUT MD720-3 from OPC Mode into the Terminal Mode, you will find the instructions for this in the chapter *Switching between Terminal mode and OPC Mode*.

## 4.2 Operating requirements: GPRS subscriber contract

To use the SINAUT MD720-3 in Terminal Mode it is required:

- SIM card of a GSM network operator including CSD data service 9600 Bit/s and a telephone number for data calls,
- Availability of a GSM network.

## 4.3 Functions of the LEDs in Terminal Mode

The device has 3 LEDs, which indicates the current operation status:

**S** (Status)      **Q** (Quality)      **C** (Connect)

LED	Status	Meaning
S, Q, C combined	Fast lighting in sequence	Boot procedure
	Synchronous slow blinking	Service mode
	Slow lighting in sequence	Update
	Synchronous fast blinking	Error
S (Status)	Blinks slowly	Device waiting for PIN input
	Blinks fast	PIN error / SIM error
Q (Quality)	Blinks slowly	Booking into GSM network
	1x intermittent blinking	Field strength not sufficient
	2x intermittent blinking	Field strength sufficient
	3x intermittent blinking	Field strength medium
	ON permanently	Field strength high
	OFF	Waiting for PIN input
C (Connect)	Blinks	Terminal mode active

Blinks slowly: 1 time each second

Blinks fast : 4 times each second



## 4.4 Terminal mode operation

To operate the device the PIN (PIN = **P**ersonel **I**dentification **N**umber) of the inserted SIM card must be known. In the Terminal Mode the PIN is not stored in the SINAUT MD720-3. The PIN must be set again everytime the device is turned-on.

- The PIN is set by AT commands.

### Control by the application

Usually the application or the application software, which you execute on a connected computer, will control the SINAUT MD720-3. So wit, the commands to establish or to disconnect a data connection via the GSM network, are given by the application to the device. For this purpose the application and the device communicates using AT commands, like other types of modems. The sending of SMS is handled in the same way.

### Direct control using AT command

You can also enter manually AT commands to control the SINAUT MD720-3. In this case use any terminal program (Refer to *Working with a terminal* program.)

Or you write your own communication program which is adapted specially to your purposes.

### Enter the PIN first

Please enter the PIN first before any other AT commands. Until a PIN has been entered most AT commands will be answered with ERROR.

## 4.5 Entering AT commands

The SINAUT MD720-3 is controlled by AT commands, which are entered either by the connected application or manually by a terminal program.

### Working with a terminal program

To be able to control the device directly via AT commands, use a terminal program, e.g. HyperTerminal.

Note the following settings:

Make the connection:	COM port to which the device is connected
Speed:	9600 Bit/s
Data bits:	8
Parity:	No
Stop bits:	1
Duplex:	Full

### PIN in Terminal-Mode

#### Enter the PIN

If the LED S blinks slowly (1 time each second), the SINAUT MD720-3 waits for a PIN entry.

In Terminal-Mode the PIN needs to be entered using the AT command AT+CPIN.

Example:

Command: **at+cpin="0000"**

Response: **OK**

The number of permitted trials to enter the PIN is limited by the SIM card.

Normally three attempts are allowed, i.e. you may enter two times back-to-back a wrong PIN, at the third attempt the right PIN must be entered, otherwise the SIM will be blocked. In this case the SIM card can only be unblocked by entering the PUK.

### **The LED S (status) blinks fast**

If the modem blinks fast (4 times each second), either the SIM card was not detected correctly or the SIM card is PUK-blocked, because a wrong PIN has been entered too often.

Please check, if the SIM card is inserted correctly (see chapter 2 *Inserting the SIM card*).

Please check, if the SIM card is PUK-blocked. Insert the SIM card into a common mobile phone. The mobile phone will display, if the SIM card is PUK-blocked. If the SIM card is PUK-blocked, please enter the PUK and then a PIN. You can use a common mobile phone to do this.

Before you enter again the SIM card into the SINAUT MD720-3, please investigate why the SIM card has been PUK-blocked: Which PIN have you entered or which PIN has your application sent to the SINAUT MD720-3?

### **Changing the SIM card**

If you change the SIM card, please do not forget to update also the PIN number in your application.

If you use a lot of SIM cards it can be helpful to set all PINs to the same PIN number. You can do this i.e. by using a mobile phone. Please observe the security requirements of your organization.

### **PIN-less SIM cards**

The device operates also with SIM cards, which PIN check is deactivated. In this case the PIN check is skipped and the device will immediately try to attach the GSM network.

## 4.6 Use AT commands

### Syntax

The AT command language is a standard for controlling modems. It is line-orientated. Each command line begins with AT (for ATtention), followed by the actual command, and ends with (Enter key).

Example: **ATD444444**↵

means: dial (D for Dial) 444444

There are only two exceptions to this rule:

The command **+++** to switch to Command Phase (see below) and the command **A** with which the last command line is repeated.

### Command phase, Transparent phase

The device accepts AT commands only when it is in Command Phase.

It is in *Command Phase*,

- when there is no active connection,
- when the sequence Pause **+++** has been entered during a connection.

The device does not accept AT commands when it is in Transparent Phase.

It is in *Transparent Phase*,

- when there is an active connection,
- when the device has been switched to Command Mode during an active connection with **+++** and then switched back to Transparent Mode with **ATO**.

### Enabling/disabling local echo

To see your entries on the screen, you may have to enable the local data echo. To do so, enter the following command: **ATE1**

To disable the local data echo, enter the following command: **ATE0**

### Enter the PIN

Command: **at+cpin="0000"**

Response: **OK**

### Network-Status request

Command: **at+creg?**

Response: **+CREG: 0,1**

### Firmware Version request

Command: **ati3**

Response: **SIE3171 SINAUT MD720-3 T.1.0.10 01.12.2005**

### CSD call outgoing:

Command: **atd0123456789**

Response: **CONNECT**

### CSD call incoming:

Response: **RING**

Command: **ata**

Response: **CONNECT**

### Sending SMS:

Command: **at+cmgf=1**

Response: **OK**

Command: **at+cmgs="phonenumber",145**

Command: **>Text of the SMS max. 160 characters; End and sending with  
mit Strg-Z**

Response: **+CMGS: 251 // value is an example**

**OK**

## 4.7 Supported AT commands in Terminal Mode

All AT commands being not listed below, will be answered with OK by the device, but the command will not be executed.

<b>+++</b> Switch from data mode to command mode	
<b>Execute command</b>	
Command:	<b>+++</b>
Response:	This command is only available during data calls. The +++ characters sequence causes to cancel de data flow over the AT interface and switch to command mode. This allows to enter AT commands while maintaining the data connection to the remote device.
Parameter:	-
Notice:	To return to data mode, use the ATO command Line does not need to end with terminating character, i.e. <CR><LF>

<b>A/</b> Repeat previous command line	
<b>Executive command</b>	
Command:	<b>A/</b>
Response:	Depend on the previous command
Parameter:	-
Notice:	Line does not need to end with terminating character, i.e. <CR><LF>

<b>ATA</b> Answer a call	
<b>Executive command</b>	
Command:	<b>ATA</b>
Response:	CONNECT[<text>] Data Connexion established OK Voice Connexion established or if cancellation of the command NO CARRIER Response if no connection
Parameter:	-
Notice:	See ATX for setup of the CONNECT message.

<b>ATD      Mobile originated Call to dial a number</b>	
<b>Executive command</b>	
Command:	<b>ATD[&lt;n&gt;]</b>
Response:	The connection cannot be established: NO DIALTONE BUSY NO CARRIER NO ANSWER Data connection successfully connected: CONNECT[<text>]
Parameter:	<n>: String of dialing digits and optionally V.25ter modifiers (dialing digits): 0-9, *, #, +, A, B, C
Notice:	-

<b>ATE      Local Echo On/Off</b>	
<b>Executive command</b>	
Command:	<b>ATE[&lt;value&gt;]</b>
Response:	OK
Parameter:	<value> : 0 Local Echo off 1 Local Echo on <Default>
Notice:	This setting determines whether or not the device echoes characters received from application during command state

<b>ATH      Disconnect existing connection</b>	
<b>Executive command</b>	
Command:	<b>ATH</b>
Response:	OK
Parameter:	-
Notice:	On this command, all calls in progress are ended

<b>ATI Request identification information</b>	
<b>Read command</b>	
Command:	<b>ATI[&lt;value&gt;]</b>
Response:	<b>&lt;text&gt;</b> (depends on <value>) <b>OK</b>
Parameter:	<b>&lt;value&gt;</b> : none: Product name and Firmware Version 0: Product name and Firmware Version 1: Product name and Firmware Version 3: Product name and Firmware Version
Notice:	<text> may take more than one line

<b>ATO Switch from command mode to data mode</b>	
<b>Executive command</b>	
Command:	ATO[n]
Response:	Device returns to data mode from command mode: CONNECT <text> If connection is not successfully resumed NO CARRIER
Parameter:	<b>&lt;n&gt;</b> 0 switch from command mode to data mode
Notice:	ATO corresponds to the +++ escape sequence.

<b>ATQ Set result code presentation mode</b>	
<b>Executive command</b>	
Command:	<b>ATQ[&lt;n&gt;]</b>
Response:	OK (if <n> = 0) Nothing (if <n> = 1)
Parameter:	<b>&lt;n&gt;</b> 0: result codes transmitted by TA <Default> 1: no result code transmitted by TA
Notice:	Specifies whether or not the device transmits any result code to the application. Information text transmitted in response is not affected by this setting.

<b>ATS0? Shows Automatic answering settings</b>	
<b>Read command</b>	
Command:	ATS0?
Response:	<n> OK
Parameter:	See ATS0=<n>
Notice:	-



<b>ATS0</b> <b>Configures Automatic answering</b>	
<b>Executive command</b>	
Command:	<b>ATS0=&lt;n&gt;</b>
Response:	OK
Parameter:	<n>: 0:          automatic answering deactivated <Default> 1-255:    number of rings before automatically answering
Notice:	-

<b>ATV</b> <b>Set result code format mode</b>	
<b>Executive command</b>	
Command:	<b>ATV[&lt;value&gt;]</b>
Response:	0          When numeric mode is activated OK        When verbose mode is activated
Parameter:	<b>&lt;value&gt; :</b> 0          Information                            <text><CR><LF> Result Code (short format):    <numeric code><CR> 1          Information                            <CR><LF><text><CR><LF> Result Code (long format):    <CR><LF><verbose code><CR> <Default>
Notice:	This parameter setting determines the contents of the header and trailer transmitted with result codes and information responses

<b>AT/Q</b> <b>Hardware Flow Control on/off</b>	
<b>Wirkbefehl</b>	
Command:	<b>ATIQ&lt;n&gt;</b>
Response:	OK
Parameter:	<n>: 0:          Hardware Flow Control (RTS/CTS) off 3:          Hardware Flow Control (RTS/CTS) on
Notice:	-

<b>ATX Set CONNECT result code Format und Call monitoring</b>																															
<b>Executive command</b>																															
Command:	<b>ATX[&lt;value&gt;]</b>																														
Response:	OK																														
Parameter:	<value>: 0 : CONNECT result code only returned, dial tone and busy detection are both disabled <Default> 1 : CONNECT<text> result code only returned, dial tone and busy detection are both disabled 2 : same as 1 3 : same as 1 4 : same as 1																														
Notice:	Result codes numeric or verbose:  <table border="0"> <tr> <td>OK</td> <td>0</td> <td>Command executed, no error, Restart executed</td> </tr> <tr> <td>CONNECT</td> <td>1</td> <td>Connection established</td> </tr> <tr> <td>RING</td> <td>2</td> <td>Ring detected</td> </tr> <tr> <td>NO CARRIER</td> <td>3</td> <td>Connection not established or interrupted</td> </tr> <tr> <td>ERROR</td> <td>4</td> <td>Command not valid</td> </tr> <tr> <td>NO DIALTONE</td> <td>6</td> <td>No dialtone, dialling not possible, wrong mode</td> </tr> <tr> <td>BUSY</td> <td>7</td> <td>Remote station busy</td> </tr> <tr> <td>CONNECT 2400/RLP</td> <td>1</td> <td>Connect at 2400 bps and Radio Link Protocol</td> </tr> <tr> <td>CONNECT 4800/RLP</td> <td>1</td> <td>Connect at 4800 bps and Radio Link Protocol</td> </tr> <tr> <td>CONNECT 9600/RLP</td> <td>1</td> <td>Connect at 9600 bps and Radio Link Protocol</td> </tr> </table>	OK	0	Command executed, no error, Restart executed	CONNECT	1	Connection established	RING	2	Ring detected	NO CARRIER	3	Connection not established or interrupted	ERROR	4	Command not valid	NO DIALTONE	6	No dialtone, dialling not possible, wrong mode	BUSY	7	Remote station busy	CONNECT 2400/RLP	1	Connect at 2400 bps and Radio Link Protocol	CONNECT 4800/RLP	1	Connect at 4800 bps and Radio Link Protocol	CONNECT 9600/RLP	1	Connect at 9600 bps and Radio Link Protocol
OK	0	Command executed, no error, Restart executed																													
CONNECT	1	Connection established																													
RING	2	Ring detected																													
NO CARRIER	3	Connection not established or interrupted																													
ERROR	4	Command not valid																													
NO DIALTONE	6	No dialtone, dialling not possible, wrong mode																													
BUSY	7	Remote station busy																													
CONNECT 2400/RLP	1	Connect at 2400 bps and Radio Link Protocol																													
CONNECT 4800/RLP	1	Connect at 4800 bps and Radio Link Protocol																													
CONNECT 9600/RLP	1	Connect at 9600 bps and Radio Link Protocol																													

<b>AT&amp;C AT&amp;C Set circuit Data Carrier Detect (DCD) function mode</b>	
<b>Executive command</b>	
Command:	<b>AT&amp;C[&lt;value&gt;]</b>
Response:	OK
Parameter:	<value> 0 : DCD line is always ON 1 : DCD line is ON in the presence of data carrier only. <Default>
Notice:	-

<b>AT&amp;D Set circuit Data Terminal Ready (DTR) function mode</b>	
<b>Executive command</b>	
Command:	<b>AT&amp;D[&lt;value&gt;]</b>
Response:	OK
Parameter:	<value>: 0: Device ignores status on DTR. <Default> 2: ON->OFF on DTR: Disconnect call, change to command mode. During state DTR = OFF is auto-answer off.
Notice:	-

<b>AT&amp;F      Restore manufactory configuration</b>	
<b>Executive command</b>	
Command:	<b>AT&amp;F</b>
Response:	OK
Parameter:	<value>: 0:      Restore parameters to manufactory values
Notice:	Restores the configuration of manufacturer of the following commands: ATE, ATQ, ATV, ATX, AT&C, AT&D and ATS0.

<b>AT&amp;W      Save stored profile</b>	
<b>Executive command</b>	
Command:	AT&W<n>
Response:	OK
Parameter:	<n> None    Saving in Profile 0 0      Saving in Profile 0
Notice:	This commands saves the current configuration in a non volatile memory of the commands ATE, ATQ, ATV, ATX, AT&C, AT&D and ATS0. The configuration can be reloaded with ATZ. Before the first saving the profile is the same as the default configuration. See also AT&V.

<b>AT&amp;V      Display current configuration</b>	
<b>Executive command</b>	
Command:	<b>AT&amp;V[&lt;value&gt;]</b>
Response:	ACTIVE PROFILE:  <b>&lt;current configuration&gt;</b>  <b>OK</b>
Parameter:	<value>: 0:      only active profile
Notice:	The configuration is a text string on multiple lines as shown in the example below. As it is dependant on the manufactory and user setup, it is impossible to list the exact number of information given

<b>AT+CPIN Enter PIN</b>	
<b>Test</b>	
Command:	<b>AT+CPIN=?</b>
Response:	OK
<b>Read command</b>	
Command:	<b>AT+CPIN?</b>
Response:	+CPIN: <code>
<b>Executive command</b>	
Command:	<b>AT+CPIN=&lt;pin&gt; [,&lt;newpin&gt;]</b>
Response:	OK
Parameter:	<p>&lt;code&gt;:                      Values reserved by this device:</p> <p>READY            Device is not pending for any password</p> <p>SIM PIN            Device is waiting SIM PIN to be given</p> <p>SIM PUK            Device is waiting SIM PUK to be given. Also, a second pin, &lt;newpin&gt;, is used to replace the old pin in the SIM and should thus be supplied</p> <p>SIM PIN2            Device is waiting SIM PIN2 to be given (this &lt;code&gt; is recommended to be returned only when the last executed command resulted in PIN2 authentication failure (i.e. +CME ERROR: 17); if PIN2 is not entered right after the failure, it is recommended that ME does not block its operation)</p> <p>SIM PUK2            Device is waiting SIM PUK2 to be given (this &lt;code&gt; is recommended to be returned only when the last executed command resulted in PUK2 authentication failure (i.e. +CME ERROR: 18); if PUK2 and new PIN2 are not entered right after the failure, it is recommended that ME does not block its operation). Also, a second pin, &lt;newpin&gt;, is used to replace the old pin in the SIM and should thus be supplied</p> <p>PH-NET PIN        ME is waiting personalization password to be given</p> <p>&lt;pin&gt;, &lt;newpin&gt;:                      string type value (8 characters max.)</p>
Notice:	-

<b>AT+CSQ Check Signal Quality</b>	
<b>Test</b>	
Command:	<b>AT+CSQ=?</b>
Response:	+CSQ: (list of supported <rssis>),(list of supported <bers> OK
<b>Response:</b>	
Command:	<b>AT+CSQ</b>
Response:	+CSQ: <rssis>,<bers> OK
Parameter:	<rssis>: 0 -113 dBm or less 1 -111 dBm 2...30 -109... -53 dBm 31 -51 dBm or greater 99 not known or not detectable <bers> (in percent) 0...7 as RXQUAL values in the table in GSM 05.08 [20] subclause 8.2.4 99 not known or not detectable
Notice:	The read command ( <b>AT+CSQ?</b> ) returns an error.

<b>AT+CGSN Request product serial number identification (IMEI) identical to GSN</b>	
<b>Test</b>	
Command:	<b>AT+CGSN=?</b>
Response:	OK
<b>Read command</b>	
Command:	<b>AT+CGSN</b>
Response:	<sn> (identification text for determination of the individual device) OK
Parameter:	-
Notice:	-

<b>AT+CGDCONT Define PDP context</b>	
<b>Test</b>	
Command:	<b>AT+CGDCONT=?</b>
Response:	+CGDCONT: (Bereich unterstützter <cid>s), <PDP_type>,,, (Liste unterstützter <d_comp>s), (Liste unterstützter <h_comp>s)
<b>Read command</b>	
Command:	<b>AT+CGDCONT=?</b>
Response:	+CGDCONT: <cid>, <PDP_type>, <APN>, <PDP_addr>, <d_comp>, <h_comp>
<b>Executive command</b>	
Command:	<b>+CGDCONT=&lt;cid&gt; ,&lt;PDP_type&gt; ,&lt;APN&gt; ,&lt;PDP_addr&gt; ,&lt;d_comp&gt; ,&lt;h_comp&gt;</b>
Response:	OK
Parameter:	<p><b>&lt;cid&gt;</b> (Local) context identification parameter</p> <p><b>&lt;PDP_type&gt;</b>: Packet Data Protocol type A string parameter which specifies the type of packet data protocol. Only IP Internet Protocol - IETF STD 5) is supported.</p> <p><b>&lt;APN&gt;</b>: Access Point Name A string parameter which is a logical name that is used to select the GGSN or the external packet data network.</p> <p><b>&lt;PDP_address&gt;</b>: A string parameter that identifies the MT in the address space applicable to the PDP. As only IP is currently supported, it shall be an IP address. If the value is null ("0.0.0.0" or 0), then a value may be provided by the TE during the PDP startup procedure or, failing that, a dynamic address will be requested. The read form of the command will continue to return the null string even if an address has been allocated during the PDP startup procedure. The allocated address may be read using the +CGPADDR command.</p> <p><b>&lt;d_comp&gt;</b>: A numeric parameter that controls PDP data compression. 0: off (default and only value supported)</p> <p><b>&lt;h_comp&gt;</b>: A numeric parameter that controls PDP header compression 0: off (default and only value supported)</p> <p><b>&lt;pd1&gt;, ... &lt;pdN&gt;</b>: Zero to N string parameters whose meanings are specific to the &lt;PDP_type&gt;</p>
Notice:	<p>The set command specifies PDP context parameter values for a PDP context identified by the (local) context identification parameter, &lt;cid&gt;. The number of PDP contexts that may be in a defined state at the same time is given by the range returned by the test command.</p> <p>A special form of the set command, +CGDCONT= &lt;cid&gt; causes the values for context number &lt;cid&gt; to become undefined.</p>

<b>AT+CGATT GPRS Attach or Detach</b>	
<b>Test</b>	
Command:	<b>AT+CGATT=?</b>
Response:	+CGATT: <state>
<b>Read command</b>	
Command:	<b>AT+CGATT?</b>
Response:	+CGATT: (list of supported <state>s)
<b>Executive command</b>	
Command:	<b>+CGATT=&lt;state&gt;</b>
Response:	OK
Parameter:	<b>&lt;state&gt;</b> Indicates the state of GPRS attachment 0: detached 1: attached
Notice:	-

<b>AT+CIMI Request international subscriber identity</b>	
<b>Test</b>	
Command:	<b>AT+CIMI=?</b>
Response:	OK
<b>Read command</b>	
Command:	<b>AT+CIMI</b>
Response:	<IMSI> (International Mobile Subscriber Identify) OK
Parameter:	-
Notice:	-

<b>AT+CPAS Phone activity status</b>	
<b>Test</b>	
Command:	<b>AT+CPAS=?</b>
Response:	+CPAS: (list of supported <pas>s) OK
<b>Read command</b>	
Command:	<b>AT+CPAS</b>
Response:	+CPAS: <pas> OK
Parameter:	<pas>: 0 ready (device allows commands from application) 1 unavailable (device does not allow commands from application) 2 unknown (device is not guaranteed to respond to instructions) 3 ringing (device is ready for commands from application, but the ringer is active) 4 call in progress (device is ready for commands from application, but a call is in progress)
Notice:	-

<b>AT+CPMS Preferred Message Storage</b>	
<b>Test</b>	
Command:	<b>AT+CPMS=?</b>
Response:	+CPMS: (list of supported <mem>s) OK
<b>Read command</b>	
Command:	<b>AT+CPMS?</b>
Response:	+CPMS: <mem>, <used>, <total> OK
<b>Executive command</b>	
Command:	<b>AT+CPMS?</b>
Response:	+CPMS: <used>, <total> OK
Parameter:	-
Notice:	Executive command selects memory storage <mem> to be used for reading, writing, etc. <u>Example:</u> AT+CPMS=? +CPMS: ("ME","SM","MT") OK AT+CPMS? +CPMS: "ME",0,100 OK AT+CPMS="ME" +CPMS: 0,100 OK



<b>AT+CNUM Subscriber number</b>	
<b>Test</b>	
Command:	<b>AT+CNUM=?</b>
Response:	OK
<b>Executive command</b>	
Command:	<b>AT+CNUM</b>
Response:	+CNUM: [<alpha1>,<number1>,<type1>[,<speed>,<service>[,<itc>]] [<CR><LF>+CNUM: [<alpha2>,<number2>,<type2>[,<speed>,<service>[,<itc>]] [...]] OK
Parameter:	<p><b>&lt;alpha&gt;:</b> optional alphanumeric string associated with &lt;number&gt;; used character set should be the one selected with command Select TE Character Set +CSCS</p> <p><b>&lt;number&gt;:</b> string type phone number of format specified by &lt;type&gt;</p> <p><b>&lt;type&gt;:</b> type of address octet in integer format (refer GSM 04.08 [8] subclause 10.5.4.7)</p> <p><b>&lt;speed&gt;:</b></p> <p><b>&lt;service&gt;:</b> service related to the phone number</p> <ul style="list-style-type: none"> <li>0: asynchronous modem</li> <li>1: synchronous modem</li> <li>2: PAD Access (asynchronous)</li> <li>3: Packet Access (synchronous)</li> <li>4: voice</li> <li>5: fax</li> </ul> <p>also all other values below 128 are reserved by the present document</p> <p><b>&lt;itc&gt;:</b> information transfer capability</p> <ul style="list-style-type: none"> <li>0: 3.1kHz</li> <li>1: UDI</li> </ul>
Notice:	<p>Action command returns the MSISDNs related to the subscriber (this information can be stored in the SIM or in the ME)</p> <p>The Read Command (AT+CNUM?) returns an error</p> <p><u>Example:</u></p> <pre>AT+CNUM      +CNUM: "TEL","0612345678",129               +CNUM: "", "",255               +CNUM: "", "",255               +CNUM: "", "",255               OK</pre>

<b>AT+CBST Select bearer service type</b>	
<b>Read command</b>	
Command:	<b>AT+CBST=?</b>
Response:	+CBST: (list of supported <speed>s),(list of supported <name>s),(list of supported <ce>s) OK
<b>Executive command</b>	
Command:	<b>AT+CBST=[&lt;speed&gt; [,&lt;name&gt;[,&lt;ce&gt;]]]</b>
Response:	OK
Parameter:	<b>&lt;speed&gt;:</b> 4        2400 bps (V.22bis) 6        4800 bps (V.32) 7        9600 bps (V.32) 68       2400 bps (V.110 or X.31 flag stuffing) 70       4800 bps (V.110 or X.31 flag stuffing) 71       9600 bps (V.110 or X.31 flag stuffing) <b>&lt;name&gt;:</b> 0        data circuit asynchronous (UDI or 3.1 kHz modem) 1        data circuit synchronous (UDI or 3.1 kHz modem) <b>&lt;ce&gt;:</b> 0        transparent 1        non-transparent
Notice:	Set command selects the bearer service <name> with data rate <speed>, and the connection element <ce> to be used when data calls are originated.

<b>AT+CMGD Delete a SMS</b>	
<b>Test</b>	
Command:	AT+CMGD=?
Response:	+CMS ERROR: <err>
<b>Read command</b>	
Command:	AT+CMGD?
Response:	+CMS ERROR: <err>
<b>Executive command</b>	
Command:	+CMGD=<index>
Response:	OK or +CMS ERROR: <err>
Parameter:	<index> 1 – n    Memory location on the SIM card; n depends on the memory capacity of the SIM card <err>    Error code
Notice:	-

<b>AT+CMGF Select SMS message format</b>	
<b>Test</b>	
Command:	AT+CMGF=?
Response:	+CMGF: (list of supported <mode>s) OK
<b>Read command</b>	
Command:	AT+CMGF?
Response:	+CMGF: <mode> OK
<b>Executive command</b>	
Command:	AT+CMGF=[<mode>]
Response:	OK
Parameter:	<mode>: 0 PDU mode 1 Text mode
Notice:	-

<b>AT+CMGL List SMS messages from preferred store</b>	
<b>Test</b>	
Command:	<b>AT+CMGL=?</b>
Response:	+CMGL: (list of supported <stat>s) OK
<b>Executive command</b>	
Command:	<b>AT+CMGL[=&lt;stat&gt;]</b>
Response:	if PDU mode (+CMGF=0) and command successful: [+CMGL: <index>, <stat>, [<alpha>], <length><CR><LF><pdu> [<CR><LF>+CMGL: <index>, <stat>, [<alpha>], <length><CR><LF><pdu> [...]] OK
Parameter:	-
Notice:	Execution command returns messages with status value <stat> from preferred message storage <mem1> . Entire data units <pdu> are returned.

<b>AT+CMGR Read SMS message</b>	
<b>Test</b>	
Command:	<b>AT+CMGR=?</b>
Response:	OK
<b>Executive command</b>	
Command:	<b>AT+CMGR=&lt;index&gt;</b>
Response:	if PDU mode (+CMGF=0) and command successful: +CMGR: <stat>,[<alpha>],<length><CR><LF><pdu> OK
Parameter:	-
Notice:	Execution command returns message with location value <index> from preferred message storage <mem1>. Status of the message and entire message data unit <pdu> is returned. If status of the message is 'received unread', status in the storage changes to 'received read'.

<b>AT+CMGS Send SMS message</b>	
<b>Test</b>	
Command:	<b>AT+CMGS=?</b>
Response:	OK
<b>Executive command</b>	
Command:	if PDU mode (+CMGF=0): <b>AT+CMGS=&lt;length&gt;&lt;CR&gt;</b> <b>PDU is given&lt;ctrl-Z/ESC&gt;</b>
Response:	if PDU mode (+CMGF=0) and sending successful: +CMGS: <mr>[,<ackpdu>] OK
Parameter:	-
Notice:	<p>&lt;length&gt; must indicate the number of octets coded in the TP layer data unit to be given (i.e. SMSC address octets are excluded)</p> <ul style="list-style-type: none"> <li>the device shall send a four character sequence &lt;CR&gt;&lt;LF&gt;&lt;greater_than&gt;&lt;space&gt; (IRA 13, 10, 62, 32) after command line is terminated with &lt;CR&gt;; after that PDU can be given from application to the device</li> <li>the DCD signal shall be in ON state while PDU is given</li> <li>the echoing of given characters back from the device is controlled by V.25ter echo command E</li> <li>the PDU shall be hexadecimal format (similarly as specified for &lt;pdu&gt;) and given in one line; the device converts this coding into the actual octets of PDU</li> <li>when the length octet of the SMSC address (given in the PDU) equals zero, the SMSC address set with command Service Centre Address +CSCA is used; in this case the SMSC Type-of-Address octet shall not be present in the PDU, i.e. TPDU starts right after SMSC length octet</li> <li>sending can be cancelled by giving &lt;ESC&gt; character (IRA 27)</li> <li>&lt;ctrl-Z&gt; (IRA 26) must be used to indicate the ending of PDU</li> </ul>

<b>AT+CREG Network registration</b>	
<b>Test</b>	
Command:	<b>AT+CREG=?</b>
Response:	+CREG: (list of supported <n>s) OK
<b>Read command</b>	
Command:	<b>AT+CREG?</b>
Response:	+CREG: <n>,<stat>[,<lac>,<ci>] OK
<b>Executive command</b>	
Command:	<b>AT+CREG=&lt;n&gt;,&lt;stat&gt;</b>
Response:	OK
Parameter:	<p><b>&lt;n&gt;:</b></p> <p>0:       disable network registration unsolicited result code</p> <p>1:       enable network registration unsolicited result code +CREG: &lt;stat&gt;</p> <p>2:       enable network registration and location information unsolicited result code +CREG: &lt;stat&gt;[,&lt;lac&gt;,&lt;ci&gt;]</p> <p><b>&lt;stat&gt;:</b></p> <p>0:       not registered, ME is not currently searching a new operator to register to</p> <p>1:       registered, home network</p> <p>2:       not registered, but ME is currently searching a new operator to register to</p> <p>3:       registration denied</p> <p>4:       unknown</p> <p>5:       registered, roaming</p> <p><b>&lt;lac&gt;:</b></p> <p>string type; two byte location area code in hexadecimal format (e.g. "00C3" equals 195 in decimal)</p> <p><b>&lt;ci&gt;:</b></p> <p>string type; two byte cell ID in hexadecimal format</p>
Notice:	Executive command controls the presentation of an unsolicited result code <b>+CREG: &lt;stat&gt;</b> when <n>=1 and there is a change in the device network registration status, or code <b>+CREG: &lt;stat&gt;[,&lt;lac&gt;,&lt;ci&gt;]</b> when <n>=2 and there is a change of the network cell.

<b>AT+CSCA SMS service center address</b>	
<b>Test</b>	
Command:	<b>AT+CSCA=?</b>
Response:	OK
<b>Read command</b>	
Command:	<b>AT+CSCA?</b>
Response:	+CSCA: <sca>,<tosca> OK
<b>Executive command</b>	
Command:	<b>AT+CSCA=&lt;sca&gt;[,&lt;tosca&gt;]</b>
Response:	OK
Parameter:	<sca> "Phone number SMS-ServiceCenters" <tosca> 129, 145
Notice:	Executive command updates the SMSC address, through which mobile originated SMS are transmitted. In text mode, setting is used by send and write commands. In PDU mode, setting is used by the same commands, but only when the length of the SMSC address coded into <pdu> parameter equals zero.

<b>AT+CSMP Set SMS text mode parameters</b>	
<b>Test</b>	
Command:	<b>AT+CSMP=?</b>
Response:	+CSMP: (list of <fo>),(list of <vp>),(list of <pid>),(list of <dc>) OK
<b>Read command</b>	
Command:	AT+CSMP?
Response:	+CSMP: <fo>,<vp>,<pid>,<dc> OK
<b>Executive command</b>	
Command:	AT+CSMP=[<fo>[,<vp>[,<pid>[,<dc>]]]]
Response:	OK
Parameter:	<fo> 17 <vp> Determines the period of time the SMS will be stored in the SMS ServiceCenter: 71      6 hours 167     24 hours 173     7 days 255     63 weeks <pid> 0 <dc> 0
Notice:	In the composite AT command AT+CMGF=1+CSMP=17,0,0,0+CSCA="+AAAAAAAAAAAA" the value 0 for <vp> will be accepted, but 0 will be replaced by the value 71.

<b>AT+CRC Set Cellular Result Codes for incoming call indication</b>	
<b>Test</b>	
Command:	<b>AT+CRC=?</b>
Response:	+CRC: (list of supported <mode>) OK
<b>Read command</b>	
Command:	<b>AT+CRC?</b>
Response:	+CRC:<mode> OK
<b>Executive command</b>	
Command:	<b>AT+CRC=[&lt;mode&gt;]</b>
Response:	OK
Parameter:	<b>&lt;mode&gt;:</b> 0:       disable extended format 1:       enable extended format
Notice:	When enabled, an incoming call is indicated with <b>+CRING: &lt;type&gt;</b> with, <b>&lt;type&gt;</b> :   FAX or VOICE

<b>AT+IPR Set fixed local rate</b>	
<b>Test</b>	
Command:	<b>AT+IPR=?</b>
Response:	+IPR: (list of supported auto-detectable <rate>s), (list of supported fixed-only <rate>s)
<b>Read command</b>	
Command:	<b>AT+IPR?</b>
Response:	+IPR: <rate> OK
<b>Executive command</b>	
Command:	<b>AT+IPR=&lt;rate&gt;</b>
Response:	OK
Parameter:	<b>&lt;rate&gt;</b> bit rate per second 1200 2400 4800 9600 14400 19200 28800 38400 57600
Notice:	-



## Composed AT-Befehle

The initialisation strings below are accepted by the SINAUT MD720-3. The reaction to the separate commands correspondingly.

### TIM device

```
ATE0S0=1&D2+CBST=71,0,1;+CRC=1;&W+IPR=19200
```

### S7-2xx-device

```
ATE0S0=0+IPR=9600
```

### Other initialisation strings

```
AT+CMGF=1+CSMP=17,0,0,0+CSCA="+AAAAAAAAAAAA"
```

```
AT+CMGS="+BBBBBBBBBB",145
```



# SINAUT MD720-3 in OPC Mode

# 5

## GPRS modem

In the OPC Mode the SINAUT MD720-3 is configured by program building blocks of the connected S7-200 PLC. The SINAUT MD720-3 establishes autonomously the radio data connection via GPRS between the connected S7-200 device and the OPC server SINAUT MICRO SC.

## SMS-Adapter

In addition also in OPC Mode the connected S7-200 device can send messages by SMS:

- directly to other subscribers of the SMS service, or
- through gateways to fax machines.

To send a SMS, the GPRS connection to the OPC server SINAUT MICRO SC will be interrupted.

## GSM-Modem

Also the SINAUT MD720-3 in OPC Mode can answer service data calls from analog modems, ISDN modems or GSM modems.

---

### Notive

You can find details about these functions in the system manual of the OPC server SINAUT MICRO SC.

---

## 5.1 OPC Mode activation

### Terminal mode is factory default setting

The SINAUT MD720-3 supports two fundamental operating modes:

- Terminal mode
- OPC Mode.

The SINAUT MD720-3 will be delivered by the factory with activated Terminal Mode.

### Automatic activation by the PLC

Operating the SINAUT MD720-3 in OPC Mode combined with S7-200 devices, the OPC Mode will be activated by the program building blocks automatically during the initialisation.

### Manual activation

If in exceptional cases a manual activation of the OPC Mode is necessary, you will find instructions in chapter 6.1 *Switching between Terminal mode and OPC Mode*.

## 5.2 Functions of the LEDs in OPC Mode

The device is equipped with 3 LEDs which indicate the status:

**S** (Status)      **Q** (Quality)      **C** (Connect)

LED	Status	Meaning
S, Q, C combined	Fast lighting in sequence Synchronous slow blinking Slow lighting in sequence Synchronous fast blinking	Boot procedure Service mode Update Error
S (Status)	Blinks slowly Blinks fast OFF ON	Device waiting for PIN input PIN error / SIM error No GPRS attach GPRS attach
Q (Quality)	Blinks slowly 1x intermittent blinking 2x intermittent blinking 3x intermittent blinking ON permanently OFF	Booking into GSM network Field strength not sufficient Field strength sufficient Field strength medium Field strength high Waiting for PIN input
C (Connect)	OFF Blinks slowly ON Blinks synchronously to data stream	No connection to MICRO SC Trying to connect MICRO SC Connected to MICRO SC Data transfer

Blinks slowly:      1 time each second

Blinks fast :      4 times each second

## 5.3 PIN in OPC-Mode

### Enter the PIN

If the LED “S” blinks slowly (1 time per second), the SINAUT MD720-3 waits for a PIN entry.

In OPC-Mode the PIN is sent by the connected PLC to the SINAUT MD720-3. Therefore you need to enter the PIN in the data module of your SPS program with reference to the program module WDC\_INIT (See System manual SINAUT MICRO SC). Please check if the PLC and the SINAUT MD720-3 are connected together.

### The LED S (Status) blinks fast

If the LED S blinks fast (4 times per second), either the SIM card was not detected or the SIM card is PUK-blocked, because the a wrong PIN has been entered too often.

1. Please check, if the SIM card has been inserted correctly into the device (refer to chapter 2 *Inserting the SIM card*).
2. Please check, if the SIM card is PUK-blocked. Insert the SIM card into a common mobile phone. The mobile phone will display, if the SIM card is PUK-blocked. If the SIM card is PUK-blocked, please enter the PUK and then a PIN. You can use a common mobile phone to do this.
3. Before you enter again the SIM card into the SINAUT MD720-3, please investigate why the SIM card has been PUK-blocked: Which PIN have you entered into your PLC program?
4. Please check and eventually reset the parameter SIMSTATE of the SINAUT MD720-3.

### Check and reset the parameter SIMSTATE

The parameter SIMSTATE will be displayed when you press the SET button (refer to 6.2 *Getting the current settings and values*):

SIMSTATE=SIM_OK	Ready for operation
SIMSTATE=SIM_ERROR	Wrong PIN; one wrong PIN entry
SIMSTATE=SIM_PROBLEM	Wrong PIN; two wrong PIN entries or no SIM detected

In case of SIMSTATE=SIM\_ERROR or SIMSTATE=SIM\_PROBLEM please proceed as follows:

1. Please make sure, that the correct PIN is entered into the PLC program module.
2. Push the SET button until the factory default settings has been loaded (Attention, all settings will be reset)

or

Enter the following AT commands:

```
AT^PARSTART
AT^PARCSE
AT^PAREND
```

3. Afterwards the device will perform a restart and is ready of operation again.

### **Changing the SIM card**

If you change the SIM card, please do not forget to update also the PIN number in your application.

If you use a lot of SIM cards it can be helpful to set all PINs to the same PIN number. You can do this i.e. by using a mobile phone. Please observe the security requirements of your organization.

### **PIN-less SIM cards**

The device operates also with SIM cards, which PIN check is deactivated. In this case the PIN check is skipped and the device will immediately try to attach the GSM network.

## 5.4 Log in to SINAUT MICRO SC

After the SINAUT MG720-3 is switched on and configured by the control or after a connection is broken off the SINAUT MD720-3 starts at once to connect itself with the OPC Server SIANAUT MICRO SC, if the SINAUT MD720-3 is in OPC mode.

If the trial of the SINAUT MD720-3 to connect with the OPC Server SIANAUT MICRO SC does not succeed it will start another trial according to the following scheme:

After switching on:	3 trials in succession
After about 3 minutes of waiting:	3 trials in succession
After about 5 minutes of waiting:	3 trials in succession
After about 15 minutes of waiting:	3 trials in succession
After about 30 minutes of waiting:	3 trials in succession
After about 60 minutes of waiting:	3 trials in succession
Always after each 60 minutes:	3 trials in succession



## 6.1 Switching between Terminal mode and OPC Mode

The SINAUT MD720-3 is delivered by the factory with activated Terminal Mode.

Operated in combination with a S7-200 the OPC Mode of the SINAUT MD720-3 will be activated by program building blocks of the connected S7-200 PLC during the initialisation.

### Manual switching

There are the following two methods to switch the SINAUT MD720-3 manually from the Terminal Mode into the OPC Mode and vice versa.

#### Method 1:

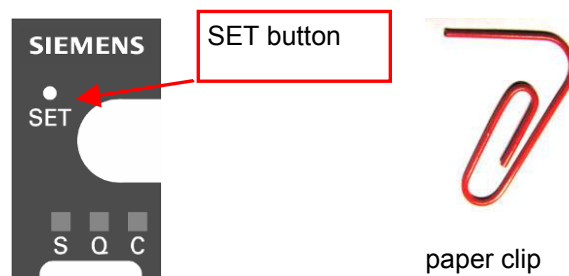

figure 6-1

Push the SET button while you are connecting SINAUT MD720-3 to the supply voltage, until the LEDs shows a fast lighting in sequence. The SINAUT MD720-3 changes the operating mode and keeps this new mode permanently until you change it again.

**Method 2:**

Change the operating mode by AT commands. Enter therefore the following commands:

**+++**

Activates the AT command interface and interrupts the data transfer.

**AT^PARSTART<CR>**

Activates the AT configuration

**AT^PARSET="TERMINAL","MODE","SUPERVISED" <CR>**

Selects the Terminal Mode, or

**AT^PARSET="TERMINAL","MODE","DISABLE" <CR>**

Selects the OPC Mode.

**AT^PAREND<CR>**

Deactivates the AT configuration and forces a restart of the SINAUT MD720-3.

The device restarts in the selected new operating mode.

## 6.2 Getting the current settings and values

Connect your PC to the interface X1 and start a terminal software, e.g. HyperTerminal. Select the used COM interface of the PC and configure the character format and the baudrate to the same settings as the X1 interface of the SINAUT MD720-3.

By factory default the SINAUT MD720-3 has the following settings:

Baudrate	9600
Character format	8N1

When you push the SET button (less than 2 seconds) the current IP configuration of the SINAUT MD720-3 is shown by the terminal software.

Assigned-IP:	Assigned IP address (OPC Mode)
Remote-Host:217.6.61.22	IP address of the OPC servers (OPC Mode)
Destination-Port:20030	Port address of the OPC server (OPC Mode)
Source-Port:26863	Own port address (OPC Mode)
Remote-Host2:	Reserved
Destination-Port2:26862	Reserved
Source-Port2:RANDOM	Reserved
Server-Mode:TSC	Reserved
Server-Line:LL	Reserved
Server-Username:st	User name at the OPC server (OPC Mode)
Server-Username2:G21	Reserved
Dial-Up:GPRS	Reserved
System-Time:1894	System time since last restart
Terminal-Mode:DISABLE	Active mode: Terminal mode or OPC Mode
Firmware-Version:V.1.2.0	Firmware-Version
SIM-STATUS:SIM-OK	SIM/PIN-Status
Provider:	GSM-Operator
NetID:	ID of the GSM-Operator
APN:	APN of the GPRS network
Quality:99	Receive quality (CSQ- value)
COM-Control:DTR	Reserved
COM-Baudrate:9600	Baudrate on X1 interface
COM-Format:8E1	Character format on X1 interface

## 6.3 Service mode to download a new firmware

When the service mode is active you can update the firmware of SINAUT MD720-3.

The firmware contains the fundamental programming of the SINAUT MD720-3. If the manufacturer has produced new firmware, for example to equip the device with new functions, then this can be loaded into the SINAUT MD720-3.

You can find the latest firmware in the internet on the pages of des Siemens Service & Support (see Foreword).

To update the firmware please proceed as follows.

### Switch on the service mode and connect the device to a PC

1. Push the SET button for 2 up to 4 seconds while the SINAUT MD720-3 is in operation. The device switches into the service mode.
2. Connect a PC to the interface X1 of the SINAUT MD720-3.

### Installation of the modem driver

For the communication with the SINAUT MD720-3 in service mode you need to install a modem driver.

1. Open the *Control Panel* in the Start Menu.
2. Using Windows XP open the category die Kategorie *Printers and Other Hardware* or switch to the Classic View.
3. Open the *Phone and Modem Options*.
4. Select Add in the register *Modems*.
5. Please follow the *Hardware-Wizard*.
6. Select *Don't detect my modem; I will select it from a list* and click *Next*.
7. Select from the manufacturer list *Standard Modem Types* the *Standard 19200 bps Modem* and click *Next*.
8. Select the COM-Port of your computer, the SINAUT MD720-3 is connected to and click *Next*.
9. Wait until the modem installation has been finished and click *Finish*.
10. In the *Phone and Modem Options* menu the *Standard 19200 bps Modem* is listed now.

11. Open the tab *Modems*, select the Standard 19200 bps modem and click *Properties*.
12. Select the tab *Modems* again and set the maximum speed to 57600. Then click *OK* twice.
13. Click *Start, Control Panel*. In the *Control Panel* window (classical view) double-click *System*, then select the tab *Hardware*.
14. Click the *Device Manager* button. In the *Device Manager* window beneath the item *Modems* double-click the Standard Modem 19200.
15. In the Properties window of this modem select the *Modem* tab. Set the speed to 57600. Close the window.

### **Installation of a Network Connection**

The communication with the SINAUT MD720-3 in service mode is made via a network connection.

1. Open the *Control Panel* in the *Start* menu.
2. Using Windows XP open the category *Network and Internet Connections*.
3. Select *Create a connection to the network at your workplace* and follow the *New Connection Wizard*.
4. Select *Dial-up connection* and click *Next*.
5. From the shown list select the *Modem – Standard 19200 bps Modem* being installed before and click *Next*.
6. Enter a name for the new connection, e.g. *Service-MD720* and click *Next*.
7. Enter the phone number **\*98#** and click *Sie Next*.
8. Finish the installation wizard by clicking *Finish*.
9. Open the *Start* Menu and select the new connection (e.g. *Service-MD720*) in the menu *Connect to*.
10. Open *Properties*, select the *Modem – Standard 19200 bps Modem* and click *Configure*.
11. Choose the Maximum speed 9600 bps. Enable the hardware flow control and disable the other options.
12. Click two times *OK* to close the *Modem Configuration* and *Properties*.

## Setup the Local Service Connection

When the modem driver and the network connection are installed and the SINAUT MD720-3 is connected to the COM-Port of the PC, the service connection can be established.

1. Open the *Start* Menu.
2. Select the new connection (e.g. *Service-MD720*) in the menu *Connect to*.
3. Enter the user name (default: *service*) and the password (default: *service*) and click *Dial*.
4. The connection will be established. After the connection is established an Icon appears in the Windows taskbar.
5. In the *Start* Menu click *All Programs, Accessories, Command Prompt*.
6. Enter the following command line: `C:\WINDOWS>ftp 192.168.0.8`  
Press Enter.
7. You will be asked for a User name (default: *service*) and a password (default: *service*). Enter both and observe capital or small characters.
8. If the connection is established successfully the message „230 User logged in“ appears and the prompt changes to `Ftp>`.

### Upload a new firmware into the SINAUT MD720-3

When the service connection is established, you can start to upload the new firmware.

1. With Notepad (belongs to Windows) create a file with the name **!cmdfile**. The file name must not have any extension (e.g.: .txt). The first line in this file is:  
STORE FirmwareName.BIN  
Instead of „FirmwareName.BIN“ write the name of the new firmware file.
2. At the Ftp>-prompt enter: **put FirmwareName.BIN**  
Press Enter. Instead of „FirmwareName.BIN“ write the name of the new firmware file.
3. Then at the Ftp>-prompt enter: **put !cmdfile**  
Press Enter.  
After the firmware file and the !cmdfile file are successfully uploaded the SINAUT MD720-3 will start to install the new firmware. This process can last up to 10 minutes. After this the SINAUT MD720-3 restarts. Then the SINAUT MD720-3 is ready again.

### Release the local service connection

Release the local service connection, if you do not need it anymore.

1. At the Ftp>-prompt enter: **quit**  
Then press Enter.
2. Then also tear-down the network connection to the device. To do so right-click the icon in the Windows task bar.

## **6.4 Load factory defaults**

By pushing the SET button for more than 4 seconds till the LED "C" begins to light up, the configuration of the SINAUT MD720-3 will be reset to factory default settings.



# Technical Data

# 7

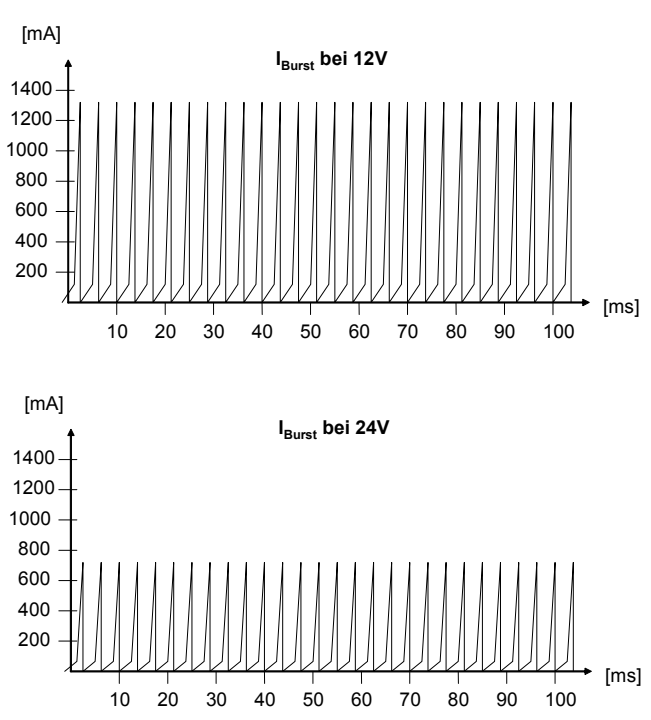
<b>Interface X1</b>	Function	GPRS connections to SINAUT MICRO SC GSM data calls (CSD 9.600 bps) MTC SMS sending
	Standard	RS232 (V.24 / V.28), plug: D-SUB 9 pins
	Default speed	9600 bps
	Control	AT commands
<b>Air interface</b>	GSM module	GPRS / CSD / Quad band
	GPRS	Up to 2 uplinks / up to 4 downlinks (max. 5 Slots)
	Transmit power	GSM 850 MHz (max. 2W), GSM 900 MHz (max. 2W), DCS 1800 MHz (max. 1W), PCS 1900 MHz (max. 1W)
	Antenna connector	SMA / 50 Ohm
<b>Power supply</b>	power consumption	typ. 5.5W
	Supply voltage	12 - 30 VDC (24 VDC nominal)
	Supply current / Established GPRS connection with data exchange	 <p><math>I_{Burst}</math> bei 12V</p> <p><math>I_{Burst}</math> bei 24V</p> <p><math>I_n</math> 430mA at 12V (<math>I_{Burst}</math> 1,3A),  <math>I_n</math> 165mA bei 24V (<math>I_{Burst}</math> 0,8A),  4,62ms Burst repetetion rate</p>

	Supply current / no connection or connection to SINAUT MICRO SC without data exchange	In 90mA at 12V In 50mA at 24V In 40mA at 30V
<b>Ambient conditions</b>	Temperature range	Operation: -20°C bis +60°C Storage: -25°C bis +85°C
	Humidity	0-95 %, not condensing
<b>Mechanics</b>	Construction	Top-hat rail housing
	Material	Synthetic material
	Protection category	IP40
	Dimensions	114 mm x 22,5 mm x 99 mm (L x W x H)
	Weight	Approx. 150g
<b>Approvals</b>	CE	Yes
	R&TTE	Yes
	EMV / ESD	EN 55024, EN 55022 Class A, EN 61000-6-2

## Interface X1

### Signals (Signal direction DTE)

Pin1	DCD	Output
Pin2	RXD	Output
Pin3	TXD	Input
Pin4	DTR	Input
Pin5	GND	Signal ground
Pin6	DSR	Output
Pin7	RTS	Input
Pin8	CTS	Output
Pin9	RI	Output

### SUB-D9 socket, Pin assignment RS232



**Modem cable for Service Interface**

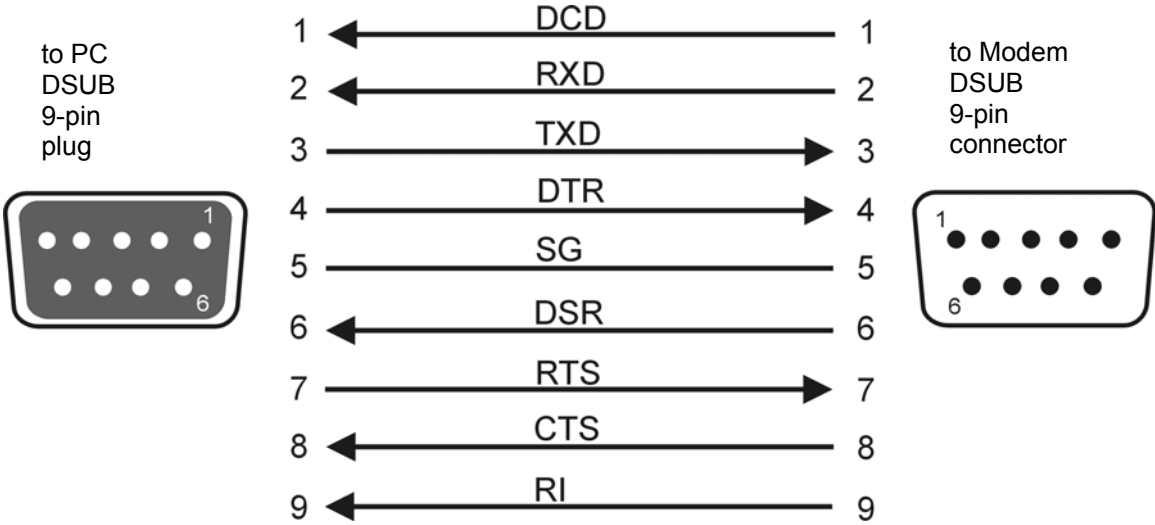

The line RI is an option.



# Glossary

# 7

<b>GSM</b> Global System for Mobile Communication	Global standard for wireless telephony, data and fax transmission and transmission of text messages (SMS). GSM based networks are available in a lot of countries world-wide, with high coverage in Europe, China, Latin America as well as in regions of the USA, Africa and Russia. Depending on the used frequencies you distinguish PCS 850MHz, GSM 900MHz, DCS 1800MHz und PCS 1900MHz networks.
<b>CSD</b> Circuit Switched Data	GSM Service for wireless data transmission at 9600 bps full duplex. Connections can be established to other GSM devices, to analogue modems or to ISDN modems in wired networks. The connections can be initialized at both sides. Only dial-up connections are supported.
<b>GPRS</b> General Packet Radio Service	GSM service for IP-based data transmission. Over GPRS network connections are established, either to the internet or to private networks.. Data are transmitted using the internet protocols TCP/IP or UDP/IP.
<b>OPC</b>	OPC covers a series of specification for data exchange in automation technologies between control devices, sensors etc. and control systems (see <a href="http://www.opcfoundation.org">www.opcfoundation.org</a> ).
<b>Protocol, transmission protocol</b>	Devices which communicate with one another must use the same rules for this communication. They must "speak the same language". Such rules and standards are collectively referred to as a protocol or transmission protocol. Often used protocols are, for example, TCP/IP and PPP.
<b>COM-Port</b>	The term "COM port" (communications port) is used to describe a serial interface (RS232) on a Windows PC. Application programs use COM ports for data transmission to various devices such as modems, PCs, terminals etc.

